

**Panasonic**  
ideas for life



**Micro-Imagechecker**  
**AX30/AX40**

# Micro-Imagechecker AX30/AX40

AX30/AX40



# Micro-Imagechecker AX30/AX40

## The Systems at a Glance

### Micro-Imagechecker

#### AX30

Colour 



- Easy to use colour image processing system
- Various ready-to-use inspection tools for a wide range of visual inspection applications
- Supports 360° contour matching function

#### AX40

Colour 

Differential 

Grey Value 

Binary 



- Everything the AX30 can do plus several functions from tried and tested A200
- Colour processing and additional grey value routines such as sub-pixel edge detection, feature extraction and smart matching
- Fast binary routines such as feature extraction
- New differential pre-processing
- Several useful add-ons such as setting help, data monitoring and display functions

- Compact and industrial stand-alone hardware
- Fast and reliable
- Time-saving setup thanks to an easy-to-use graphical interface
- Two colour-CCD cameras connectable
- Serial, parallel and Ethernet interfaces
- VGA-monitor connection
- Data storage of Compact Flash memory cards
- Support dual language menu
- Optional project management software AXTOOL

### Contents:

The Systems at a Glance	.3
Hardware Highlights	.4
Software Highlights	.6
Special Features	.8
User Interface	.10
Inspection Functions	.11
Software AXTOOL	.12
Technical Data	.13
System Configuration and Dimensions	.14
Accessories	.15

# Micro-Imagechecker AX30/AX40

## Hardware Highlights



### Compact and industrial

With their dimensions of just 130 x 59 mm, AX30/AX40 Imagecheckers help you realise the growing demand of downsizing equipment. They permit space saving DIN-rail installation in a switching cabinet or direct mounting at the inspection site. All interface connectors are located on the front side, which makes it easy to install and service the systems. Furthermore, they have an impressive record in industrial safety, which results also from the fact that they do not employ any mechanical parts such as fans or hard disks.



### Precise and reliable

Being the successors to our successful A-Series Imagecheckers, AX30/AX40 systems inherit proven image-processing technology built up over many years. These high-precision devices ensure advanced quality inspection of your products, since they include colour data in the evaluation process. They are designed as stand-alone devices with a proprietary operating system and a dedicated inspection firmware.

The systems are ready for operation immediately after power up and can provide inspections 24 hours per day, 365 days a year.



### Powerful dual camera inspection

AX Series Imagecheckers include a dedicated 32-bit RISC CPU that secures a high-performance inspection level. Besides the short response time, the systems enable very powerful inspection algorithms, such as those used for the newly developed contour matching. They detect objects reliably, even if they partially overlap or if ambient light changes.

AX30/AX40 process the images of up to two colour CCD cameras in parallel and output inspection results after a few milliseconds.

# Micro-Imagechecker AX30/AX40

## A Sophisticated Hardware Concept

### Indicator LEDs

- Display of all essential signals on the controller

### DIN rail installation

- One touch at the rear, is all that is required for DIN rail installation

### Ethernet port

- 100 Base-Tx
- Several backup/restore functions
- Optional: AXTOOL software

### Compact flash memory card slot

- Backup/restore of camera images, screenshots and project data
- Very reliable, rugged and cost efficient storage media

### Two serial ports<sup>1)</sup>

- Communicate with PCs and/or PLCs
- Direct connection to various PLCs without programming efforts

### Keypad interface

- Easy video-game-like setting with a four-button keypad

### Parallel I/O

- 14 digital outputs for judgement and result data output plus additional signals for error, ready, flash-light trigger, etc.
- 13 digital inputs for program change teach-in, etc.
- PhotoMOS technology

### Two colour cameras connectable

- Single chip CCD technology
- Fast progressive scan image capturing
- All camera parameters adjustable via software
- Miniature camera design

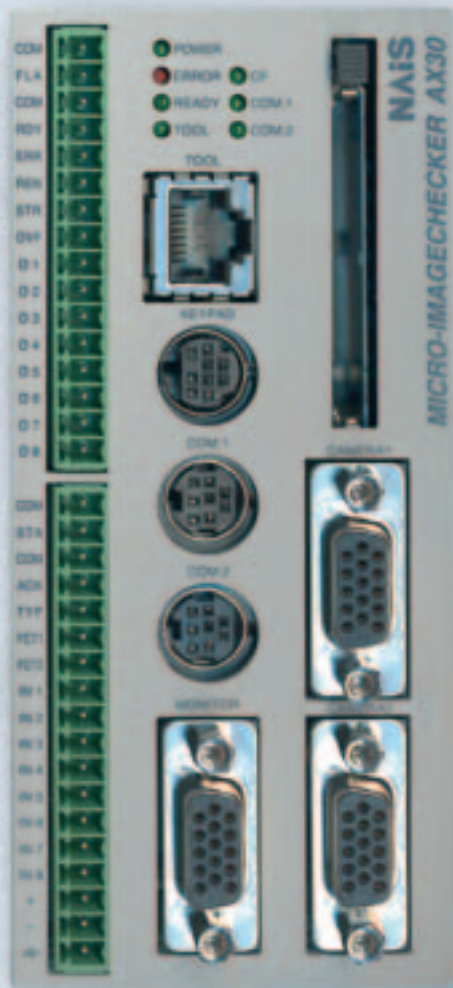

Original Product size

### VGA-monitor interface

- High-quality display (flicker-free)
- Use of cost effective standard monitors

<sup>1)</sup> Cannot be used simultaneously



# Micro-Imagechecker AX30/AX40

## Software Highlights

Colour image processing opens a new world of possibilities.

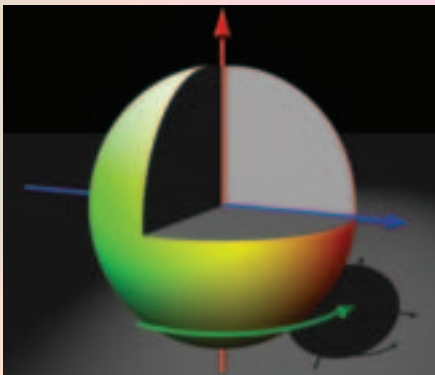

### Human eye-like sensitivity

The colour recognition/extraction algorithms of AX30 and AX40 are based on the LCH (luminosity, chroma and hue) mode, which covers all colours a human eye can recognise. This mode allows for colour recognition more similar to that of the human eye than conventional RGB-mode colour extraction.

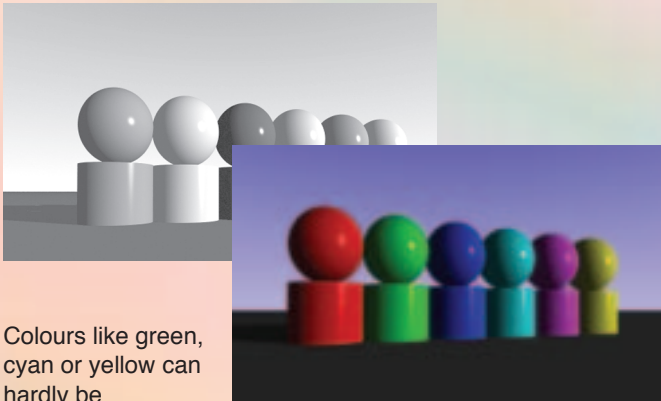

Colours like green, cyan or yellow can hardly be distinguished in grey colour pictures.

Only a colour system makes reliable control possible.

### Numerous advantages

- Independent evaluation of luminance, saturation and hue
- Low influence by variation in luminance
- Higher recognition certainty
- Reliable detection of objects barely distinguishable in grey colour pictures

### Inspection examples



#### Colour Detection, Presence Checking

Measures the area of the specified region or pre-defined colours to detect foreign objects, perform presence checking, sort or count objects.



#### Size Measurement

Grey-scale based inspection functions such as edge finders allow the system to measure dimensions, angles, diameters, radii, etc. with sub-pixel resolution.





### Fast and easy setup

Our newly designed user interface allows you to set up your inspection routine quickly. The clearly structured screen with its pull-down menus, semitransparent spreadsheets and indicators makes it easy to configure the AX30 or AX40 to each individual application, even for non-experts.

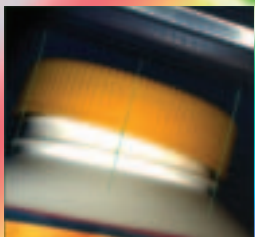

### Position detection

Several algorithms in the systems are made for precisely detecting the position of an object. x/y coordinates and the rotation angle are typically output.



### Matching

Advanced matching functions such as contour-matching and smart matching<sup>1)</sup> can be used to identify or to validate object details reliably and efficiently.



<sup>1)</sup> AX40 only

# Micro-Imagechecker AX30/AX40

## Special Features

### 360° contour-matching

By calculating contour lines and judging, stable positional detection is possible even for hidden, overlapped objects that have been difficult to detect up to now. Thanks to this, better yields are achieved.

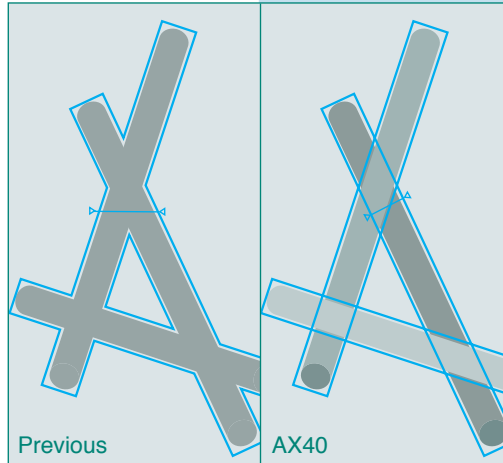

### Versatile rotational and positional adjustment

Highly accurate and reliable inspection is realized by automatically adjusting object orientation and stop-position deviation. Since adjustment is done using grey scale data, the AX40 shows its strength when it comes to changes in brightness. Complicated adjustments are possible because of the priority adjustment function.



### Mask

The shape of the inspection area can be set to match particular targets. Also, mask area settings can be combined so that efficient inspection can be carried out just for a required part.

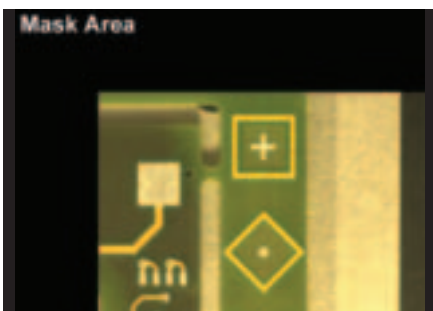

### Colour tone diagram

Fine adjustment for color inspection is possible. Even when colors resemble each other, the target color alone can be extracted to enable highly accurate inspection.

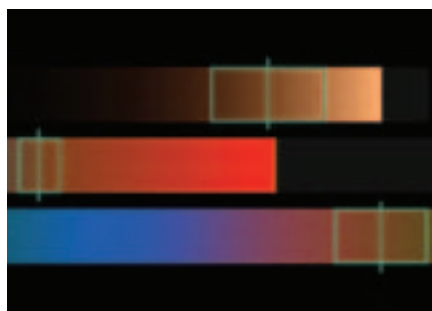

### Print screen

You can save setting displays or displays that occur during operation as bitmaps on a memory card. This is convenient for creating documents or for verifying previously shot images.



# Micro-Imagechecker AX30/AX40

## Additional Features of the AX40

### 1 System – 4 inspection modes

AX40 commands four different inspection modes: colour, binary, grey-scale and differential image processing. Combined with a large pool of ready-made and easy-to-configure inspection functions such as 360° contour-matching and smart matching, AX40 can handle nearly any inspection task.



#### Full colour

- LCH mode for human-eye like colour inspection
- Suitable for various inspection tasks such as sorting, counting, parts recognition, etc.

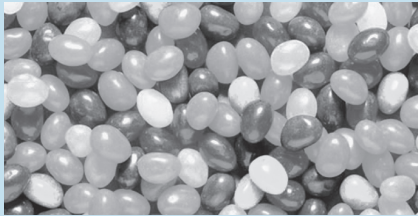

#### Grey scale

- 256 grey tones for precise measurement, positioning, etc.

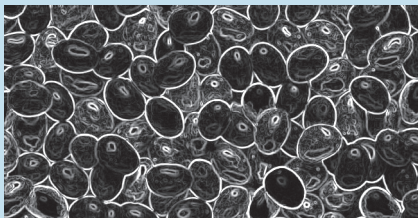

#### Differential

- Extracts edges/changes in the image data
- Ideal method e.g. for surface inspection

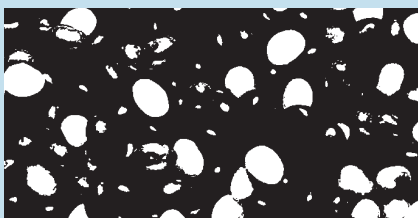

#### Binary

- A reduction of the image data to black and white pixels allows fastest inspection

#### Data monitor

Up to 50 inspection results are displayed on the monitor in chart form for operator verification. Also, threshold adjustment (upper and lower limit values) can be changed on the data monitor without entering them in the setting menu.

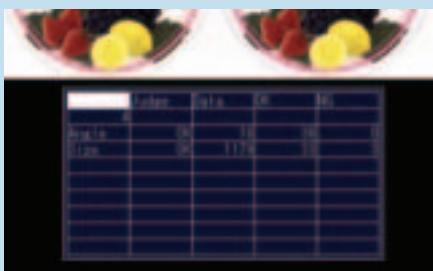

#### Statistical support

Data can be tracked, e.g. as maximum value, minimum value, average value, and number of NG (no-good) results. Maximum, minimum, average and other OK judgment values can be verified, which is useful as a guide for making upper and lower limit settings.



#### Smart matching

Grey scale matching makes sub-pixel positional detection possible

Furthermore, shape inspection, such as for the detection of chipped objects, can be carried out simultaneously with the grey scale difference processing function

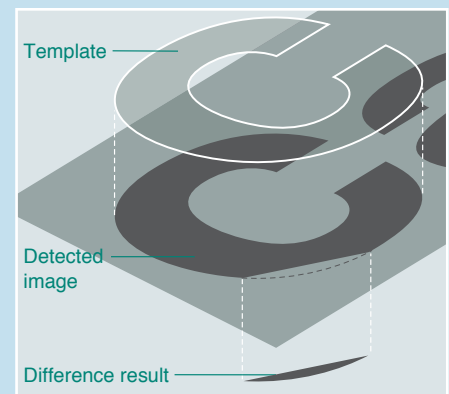

#### Numerical calculation/judgement output

The computation function, which has been troublesome up to now, now can be easily made, even by beginners. Also, operation has become even easier thanks to the ability to set both numerical calculation and judgement output on the same screen.



# Micro-Imagechecker AX30/AX40

## User-friendly User Interface

### Intuitive and clearly arranged

Colour window achieves unrivaled ease of operation!  
Select colours to detect right on the screen.

System uses 18-dot fonts.

Operating systems equipped with pull-down menus and dialogue windows. System closer to "look and feel" of Windows applications for more intuitive operation.

Easy-to-see overall pass/fail result display.

Reserved area for status display (128 x 480). Display results and more without affecting the camera image.

Easy-to-see semitransparent menu screen. Configure various settings while viewing captured image.

Image display area (512 x 480)

Our newly designed user interface saves you time and allows you to set your visual inspection routine efficiently. The clearly structured screen with its pull-down menus, semitransparent spreadsheets and indicators makes it easy even for non-experts to adjust AX30/AX40 to each individual application. The big overall good/bad display as well as the status indicators give you reliable output information any time during the setting and inspection procedure. Since AX30/AX40 has a standard VGA interface, it can be connected to any normal computer monitor.

#### Other highlights:

- Password protection
- Multiple language configuration (German, English, French, etc.)
- Setting help for focus and aperture (AX40)

# Micro-Imagechecker AX30/AX40

## Inspection Functions



**AX30/AX40 Imagecheckers** can be used for a wide range of visual inspection applications such as 2D measurement, presence/absence checking, object position detection, object identification, sorting, counting, print inspection, colour discrimination and much more. Here are the inspection tools available in detail:

### Position Detection

Detect the object position relative to a specified reference point, detect rotations or displacements of objects. Output object position or adjust other checkers accordingly.

### Object Feature Detection

Identify objects and their position based on significant object features or differences. Count, sort and categorise objects.

### Area Measurement

Measure the area of pixels in order to check the presence/absence of certain object features, to detect foreign objects, etc.

### 360° Contour-Matching

Detect contours in the current camera image and output the correlation of the found object with the given contour.

### Size Measurement

Measure dimensions, distances and widths of objects or of object features. Determine diameters, radii, angles, etc.

### Smart Matching

Detect an object based on stored reference templates and extracts the differences between the two images to find e.g. minute imperfections in imprints or faulty print images on discrete parts.

## Overview of inspection functions

Feature	AX30 Micro-Imagechecker	AX40 Micro-Imagechecker
<b>PRE-PROCESSING</b>		
Colour extraction	●	●
Grey scale	○	●
Differential processing	○	●
<b>PROCESSING</b>		
Position Detection		
X/Y	●	●
Angle	●	●
Area Measurement		
Colour extraction	●	●
Grey scale	○	●
Size Measurement		
Colour (pixel)	●	●
Grey scale (sub-pixel)	○	●
Object/Feature Detection		
Colour extraction	●	●
Colour (advanced)	○	●
Grey (advanced)	○	●
360° Contour-Matching		
Colour extraction	●	●
Grey	○	●
Smart Matching		
Grey scale	○	●
<b>POST-PROCESSING</b>		
Advanced result calculation	○	●

# Micro-Imagechecker AX30/AX40

## Software AXTOOL

### AXTOOL

This new software tool makes it very convenient to administer and organise your AX30/AX40 projects comprehensively by drag & drop.

AXTOOL allows direct access to AX30/AX40 project data and images. It is easy to back up and to restore inspection program information from/to your computer and to organise this data.

An integrated image viewer allows you to display and print out saved images. Last but not least the 'Documenter' gives you a detailed insight into each inspection program and simplifies project documentation and archiving.

Navigator

Saved image display

Set data display screen

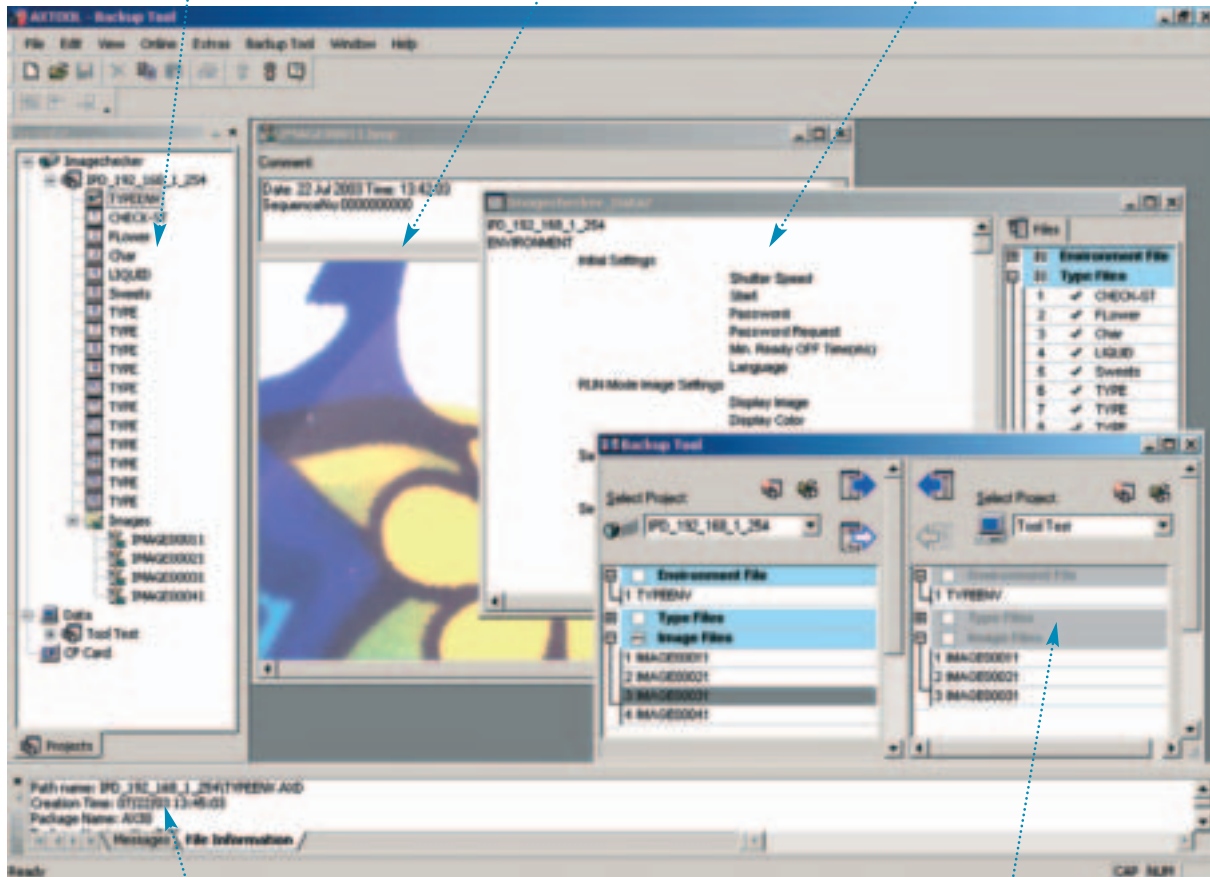

Message area

Communication screen

# Micro-Imagechecker AX30/AX40

## Technical Data

### Main Unit

Micro-Imagechecker	AX30	AX40
PART NUMBER		
English/German	ANMX304	ANMX404
French/English	ANMX305	ANMX405
CPU	32-bit RISC	
RESOLUTION	512 (h) x 480 (v) pixel	
PROCESSING	2 x 8 colours	2 x 8 colours 8-bit grey scale processing 8-bit differential processing
INTERFACES		
Serial	COM port: RS232C (max. speed 115,200 bps)	
Parallel	13-point input, 12-24VDC, bipolar (NPN/PNP), optically coupled 14-point output, 12-24VDC, bipolar (NPN/PNP), optically coupled	
Ethernet	100Base-Tx, 10Base-T	
Storage device	Compact Flash Memory Card, type I, max. 512 MB	
NUMBER OF CAMERAS CONNECTABLE	2	
VISUALISATION	1 colour-VGA connection	
SUPPLY VOLTAGE	24 VDC	
CURRENT CONSUMPTION	< 0.9 A	
OPERATING TEMP. RANGE	0 to 50 °C (no frost or condensation)	
WEIGHT	Approx. 450 g	

### Camera

Micro-Imagechecker	AX30	AX40
PART NUMBER	ANMX8310	
IMAGE SENSOR	1/3" CCD, 659 x 494 square pixels	
LENS MOUNT	C mount	
SHUTTER SPEED	1/30, 1/100, 1/250, 1/500, 1/1000, 1/2000, 1/4000, 1/10000 s	
OPERATING TEMPERATURE	Guaranteed performance range: 0 to 40 °C Allowed operating temperature range: 0 to 50 °C (no frosting, no condensation)	
VIBRATION RESISTANCE	10 to 55 Hz; 1 sweep/min, vibration width 1.2 mm, 30 min each in x, y, z directions	
SHOCK RESISTANCE	700 m/s <sup>3</sup> , 3 times each x, y, z directions	
WEIGHT	Approx. 70 g (excluding camera cable, lens and camera mounting brackets)	

All specifications are subject to change without further notice.

# Micro-Imagechecker AX30/AX40

## System Configuration and Dimensions

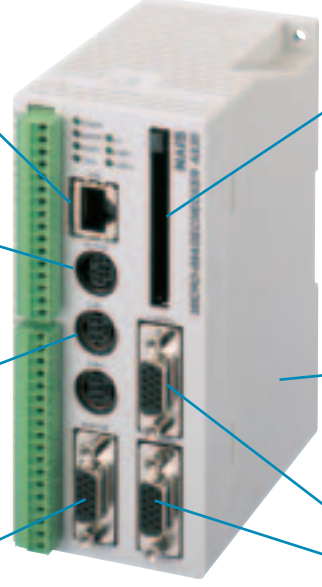

Standard internal Ethernet interface.  
High-speed interface with AXTOOL makes backing up images and product type data a snap.

Easy configuration with a handy keypad.

RS232C port makes communicating with PLCs and other external devices a snap. Program-less connection via our PLC protocol as well as PLCs of other companies.

Supports dedicated 6.5-inch colour LCD VGA monitor.

Supports max. 512MB CompactFlash™ card\*. Save all that configuration data, image data and display-screen data.

Supports flashlight. Large range of lights and objectives available.

Connects up to two colour cameras.

\* CompactFlash™ is a registered trademark of Sun Disk Inc., US.

## Dimensions

### ● Main unit (Controller) AX30/AX40

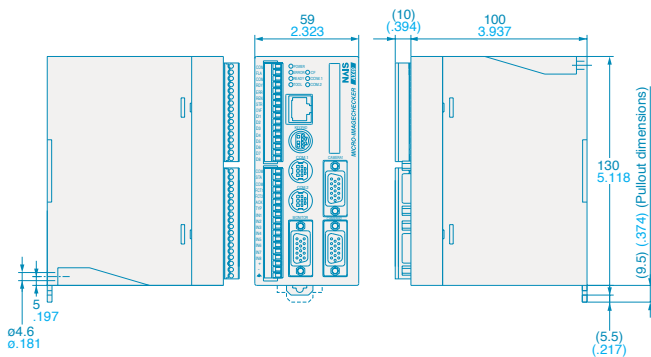

(Unit: mm inch)

### ● Dedicated colour camera:

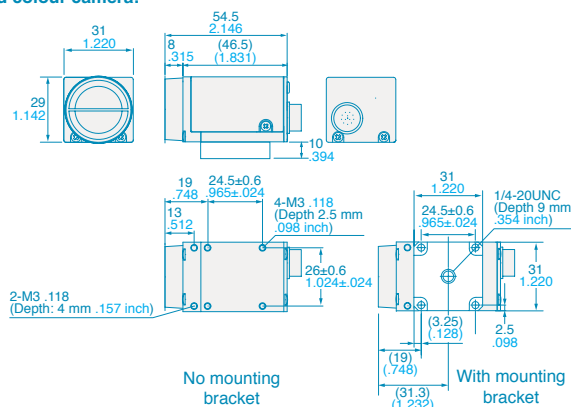

## North America

## Europe

## Asia Pacific

## China

## Japan

### Panasonic Electric Works

Please contact our Global Sales Companies in:

#### Europe

▶ <b>Headquarters</b>	<b>Panasonic Electric Works Europe AG</b>	Rudolf-Diesel-Ring 2, 83607 Holzkirchen, Tel. +49 (0) 8024 648-0, Fax +49 (0) 8024 648-111, <a href="http://www.panasonic-electric-works.com">www.panasonic-electric-works.com</a>
▶ <b>Austria</b>	<b>Panasonic Electric Works Austria GmbH</b>	Josef Madersperger Str. 2, 2362 Biedermannsdorf, Tel. +43 (0) 2236-26846, Fax +43 (0) 2236-46133 <a href="http://www.panasonic-electric-works.at">www.panasonic-electric-works.at</a>
	<b>PEW Electronic Materials Europe GmbH</b>	Ennshafenstraße 30, 4470 Enns, Tel. +43 (0) 7223 883, Fax +43 (0) 7223 88333, <a href="http://www.panasonic-electronic-materials.com">www.panasonic-electronic-materials.com</a>
▶ <b>Benelux</b>	<b>Panasonic Electric Works Sales Western Europe B.V.</b>	De Rijn 4, (Postbus 211), 5684 PJ Best, (5680 AE Best), Netherlands, Tel. +31 (0) 499 372727, Fax +31 (0) 499 372185, <a href="http://www.panasonic-electric-works.nl">www.panasonic-electric-works.nl</a>
▶ <b>Czech Republic</b>	<b>Panasonic Electric Works Czech s.r.o.</b>	Průmyslová 1, 34815 Planá, Tel. (+420-)374 799 990, Fax (+420-)374 799 999, <a href="http://www.panasonic-electric-works.cz">www.panasonic-electric-works.cz</a>
▶ <b>France</b>	<b>Panasonic Electric Works Sales Western Europe B.V.</b>	Succursale française, 10, rue des petits ruisseaux, 91370 Verrières Le Buisson, Tél. +33 (0) 1 6013 5757, Fax +33 (0) 1 6013 5758, <a href="http://www.panasonic-electric-works.fr">www.panasonic-electric-works.fr</a>
▶ <b>Germany</b>	<b>Panasonic Electric Works Europe AG</b>	Rudolf-Diesel-Ring 2, 83607 Holzkirchen, Tel. +49 (0) 8024 648-0, Fax +49 (0) 8024 648-111, <a href="http://www.panasonic-electric-works.de">www.panasonic-electric-works.de</a>
▶ <b>Hungary</b>	<b>Panasonic Electric Works Europe AG</b>	Erdőalja út 91/a, 1037 Budapest, Tel. +36 (0) 20 9715688, <a href="http://www.panasonic-electric-works.hu">www.panasonic-electric-works.hu</a>
▶ <b>Ireland</b>	<b>Panasonic Electric Works UK Ltd.</b>	Irish Branch Office, Dublin, Tel. +353 (0) 14600969, Fax +353 (0) 14601131, <a href="http://www.panasonic-electric-works.co.uk">www.panasonic-electric-works.co.uk</a>
▶ <b>Italy</b>	<b>Panasonic Electric Works Italia srl</b>	Via del Commercio 3-5 (Z.I. Ferlina), 37012 Bussolengo (VR), Tel. +39 (0) 456752711, Fax +39 (0) 456700444, <a href="http://www.panasonic-electric-works.it">www.panasonic-electric-works.it</a>
▶ <b>Nordic Countries</b>	<b>Panasonic Electric Works Nordic AB</b>	Sjöängsvägen 10, 19272 Sollentuna, Sweden, Tel. +46 859476680, Fax +46 859476690, <a href="http://www.panasonic-electric-works.se">www.panasonic-electric-works.se</a>
▶ <b>Poland</b>	<b>Panasonic Electric Works Polska sp. z o.o.</b>	Jungmansgatan 12, 21119 Malmö, Tel. +46 40 697 7000, Fax +46 40 697 7099, <a href="http://www.panasonic-fire-security.com">www.panasonic-fire-security.com</a>
▶ <b>Portugal</b>	<b>Panasonic Electric Works España S.A.</b>	ul. Wołoska 9A, 02-583 Warszawa, Tel. +48 (0) 22 338-11-33, Fax +48 (0) 22 338-12-00, <a href="http://www.panasonic-electric-works.pl">www.panasonic-electric-works.pl</a>
▶ <b>Spain</b>	<b>Panasonic Electric Works España S.A.</b>	Portuguese Branch Office, Avda Adelino Amaro da Costa 728 R/C J, 2750-277 Cascais, Tel. +351 214812520, Fax +351 214812529
▶ <b>Switzerland</b>	<b>Panasonic Electric Works Schweiz AG</b>	Barajas Park, San Severo 20, 28042 Madrid, Tel. +34 913293875, Fax +34 913292976, <a href="http://www.panasonic-electric-works.es">www.panasonic-electric-works.es</a>
▶ <b>United Kingdom</b>	<b>Panasonic Electric Works UK Ltd.</b>	Grundstrasse 8, 6343 Rotkreuz, Tel. +41 (0) 41 7997050, Fax +41 (0) 41 7997055, <a href="http://www.panasonic-electric-works.ch">www.panasonic-electric-works.ch</a>
		Sunrise Parkway, Linford Wood, Milton Keynes, MK14 6LF, Tel. +44 (0) 1908 231555, Fax +44 (0) 1908 231599, <a href="http://www.panasonic-electric-works.co.uk">www.panasonic-electric-works.co.uk</a>

#### North & South America

▶ <b>USA</b>	<b>PEW Corporation of America</b>	629 Central Avenue, New Providence, N.J. 07974, Tel. 1-908-464-3550, Fax 1-908-464-8513, <a href="http://www.pewa.panasonic.com">www.pewa.panasonic.com</a>
--------------	-----------------------------------	---

#### Asia Pacific/China/Japan

▶ <b>China</b>	<b>Panasonic Electric Works (China) Co., Ltd.</b>	Level 2, Tower W3, The Towers Oriental Plaza, No. 2, East Chang An Ave., Dong Cheng District, Beijing 100738, Tel. (010) 5925-5988, Fax (010) 5925-5973
▶ <b>Hong Kong</b>	<b>Panasonic Electric Works (Hong Kong) Co., Ltd.</b>	RM1205-9, 12/F, Tower 2, The Gateway, 25 Canton Road, Tsimshatsui, Kowloon, Hong Kong, Tel. (0852) 2956-3118, Fax (0852) 2956-0398
▶ <b>Japan</b>	<b>Panasonic Electric Works Co., Ltd.</b>	1048 Kadoma, Kadoma-shi, Osaka 571-8686, Japan, Tel. (06) 6908-1050, Fax (06) 6908-5781, <a href="http://panasonic-electric-works.net">http://panasonic-electric-works.net</a>
▶ <b>Singapore</b>	<b>Panasonic Electric Works Asia Pacific Pte. Ltd.</b>	101 Thomson Road, #25-03/05, United Square, Singapore 307591, Tel. (06255) 5473, Fax (06253) 5689